



US00D638505S

(12) **United States Design Patent**
Kakizaki

(10) **Patent No.:** **US D638,505 S**

(45) **Date of Patent:** **** May 24, 2011**

(54) **GOLF CLUB HOSEL**

(75) Inventor: **Hidejiro Kakizaki**, Kanagawa (JP)

(73) Assignee: **Arm Tec Co., Ltd.**, Tokyo (JP)

(**) Term: **14 Years**

(21) Appl. No.: **29/361,237**

(22) Filed: **May 7, 2010**

(51) **LOC (9) Cl.** **21-02**

(52) **U.S. Cl.** **D21/759**

(58) **Field of Classification Search** D21/733-752,
D21/759; 473/324-331, 340-346, 350

See application file for complete search history.

(56) **References Cited**

U.S. PATENT DOCUMENTS

3,529,826 A * 9/1970 Hulyk 473/313

D368,506 S * 4/1996 Izett et al. D21/740

* cited by examiner

Primary Examiner — Mitchell I Siegel

(74) *Attorney, Agent, or Firm* — Greenblum & Bernstein P.L.C.

(57) **CLAIM**

I claim the ornamental design for a golf club hosel, as shown and described:

DESCRIPTION

FIG. 1 is a perspective view of an embodiment of a golf club hosel, showing my new design;

FIG. 2 is a front elevational view of the embodiment of FIG. 1;

FIG. 3 is a rear elevational view of the embodiment of FIG. 1; FIG. 4 is a right side elevational view of the embodiment of FIG. 1;

FIG. 5 is a left side elevational view of the embodiment of FIG. 1;

FIG. 6 is a top plan view of the embodiment of FIG. 1; and,

FIG. 7 is a bottom plan view of the embodiment of FIG. 1. The broken lines indicate structure that is for illustrative purposes only and forms no part of the claimed design.

1 Claim, 7 Drawing Sheets

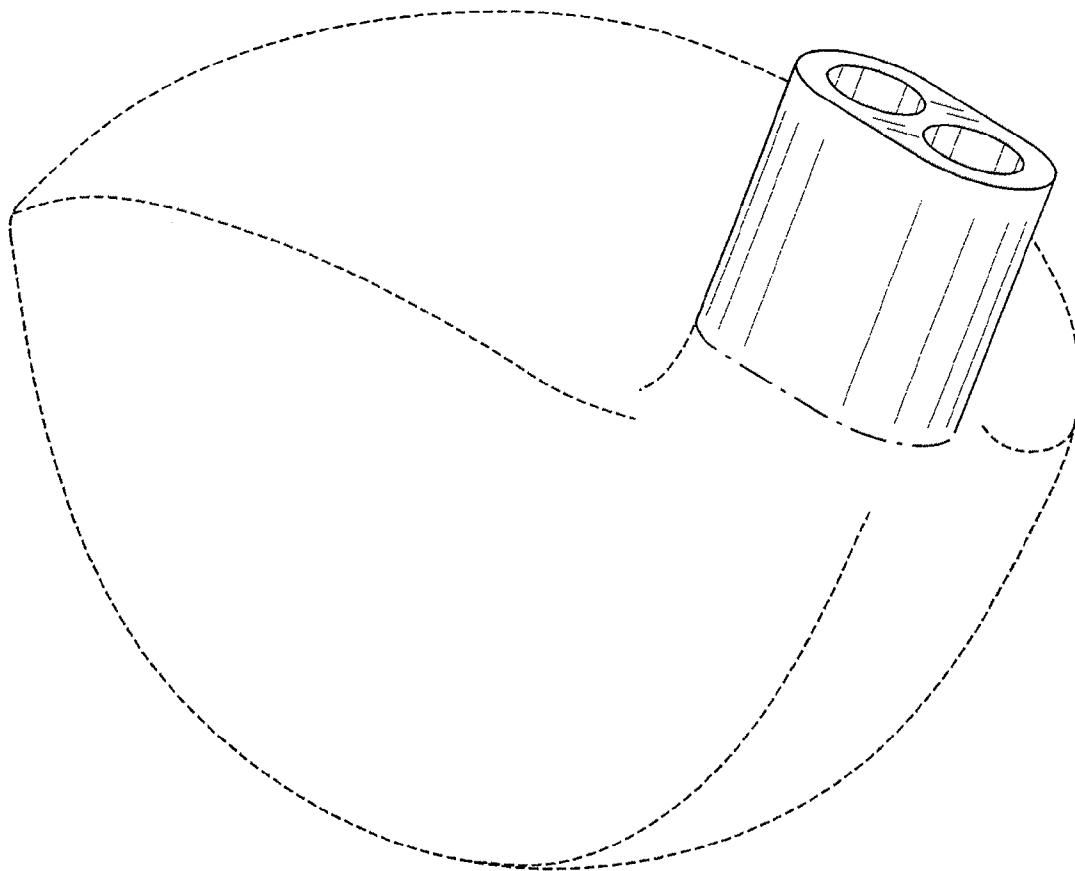

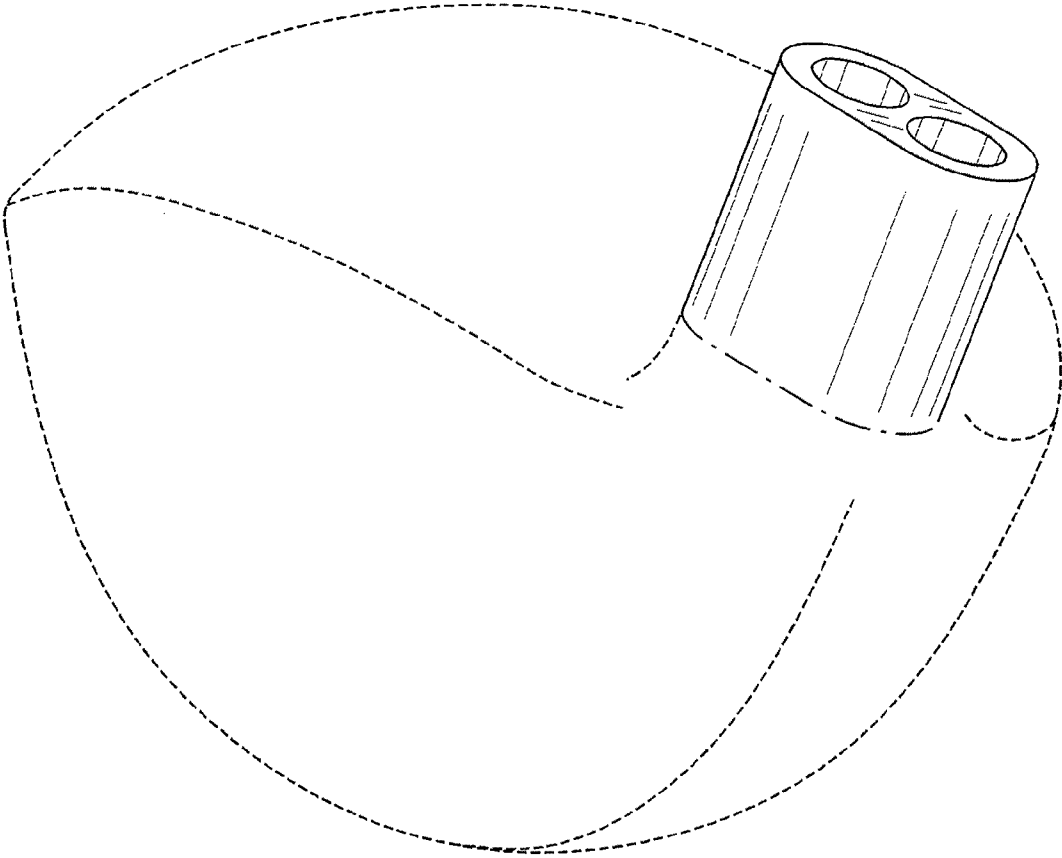

FIG. 1

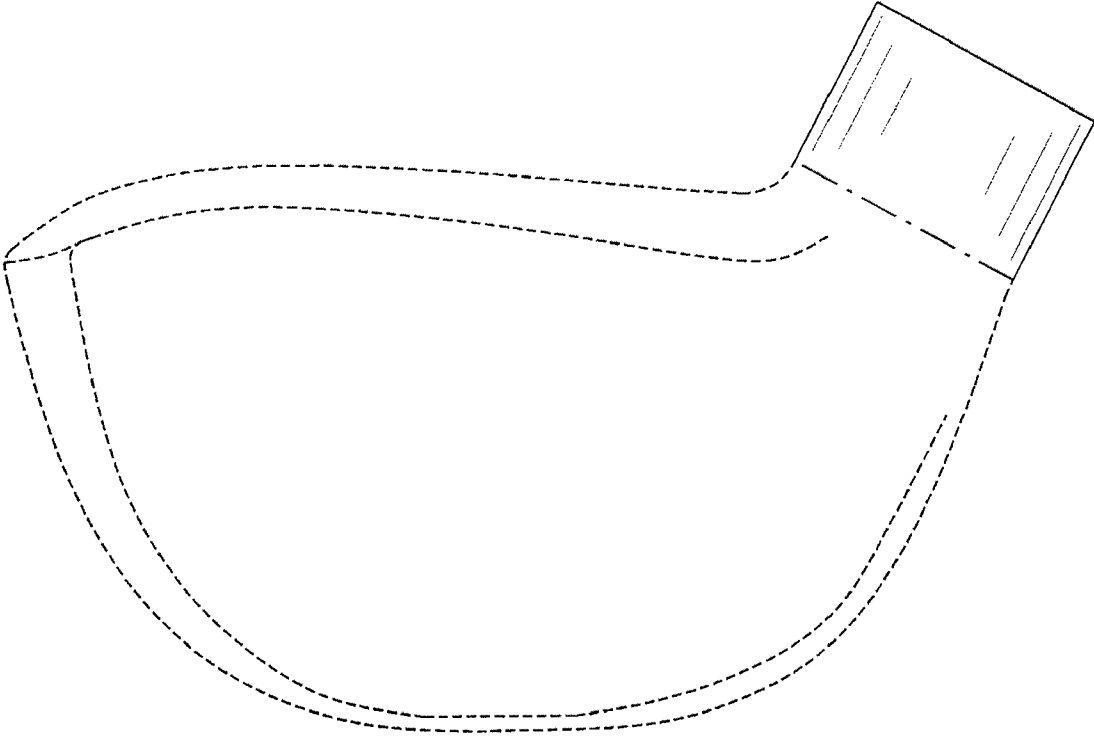

FIG.2

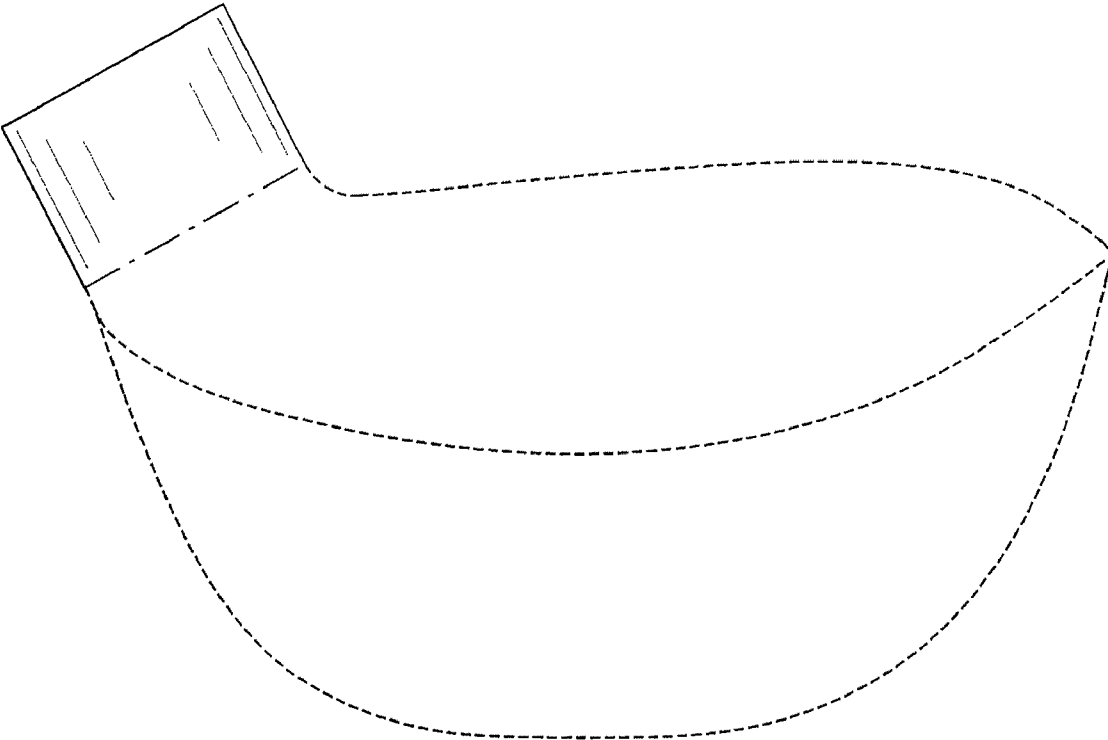

FIG.3

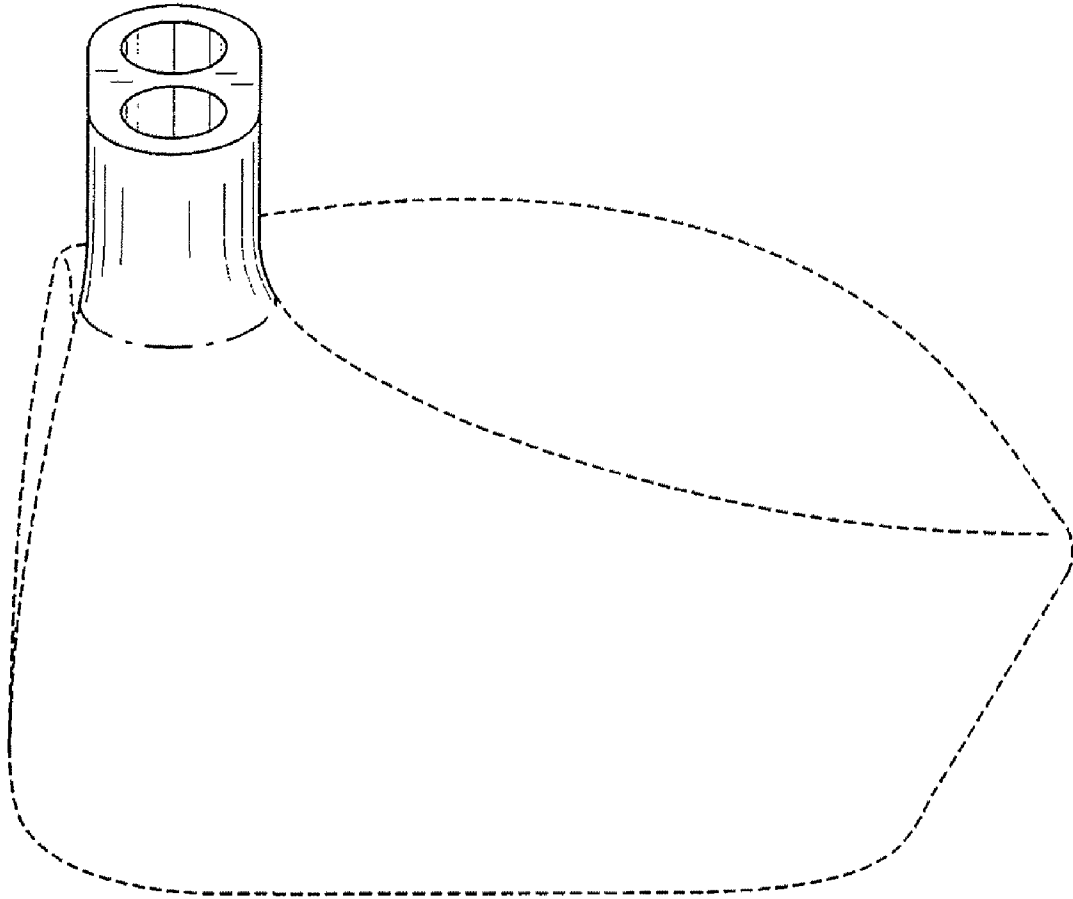

FIG.4

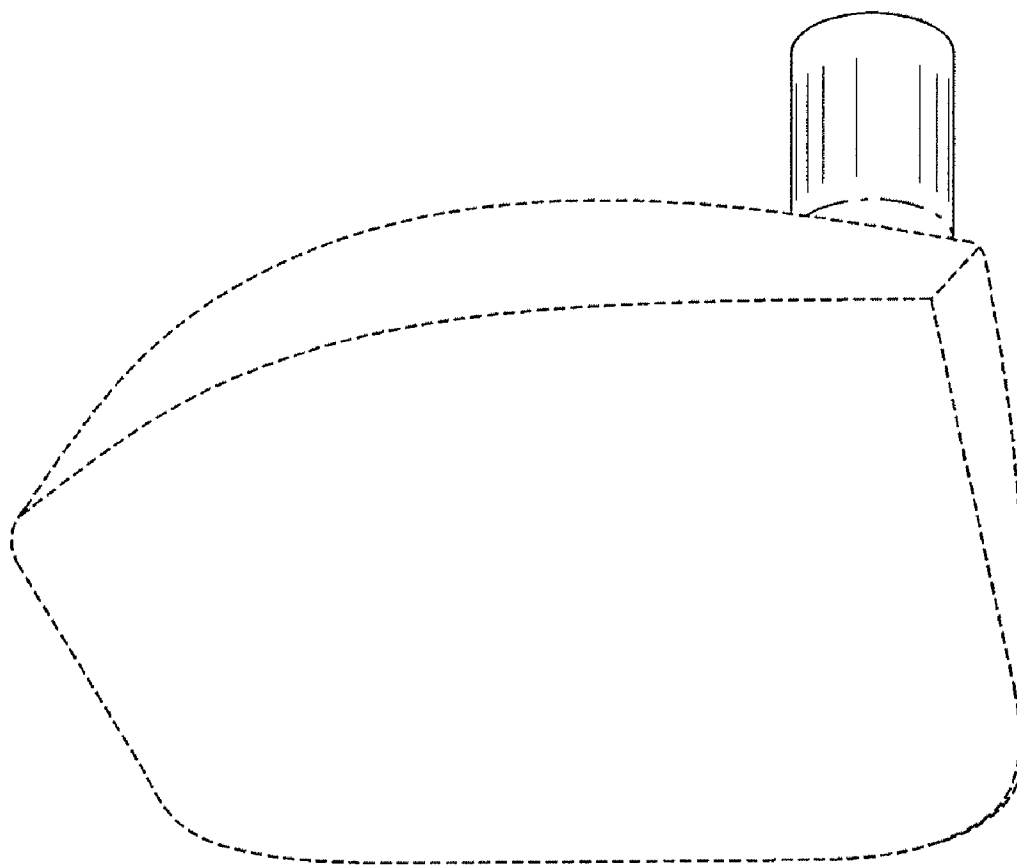

FIG.5

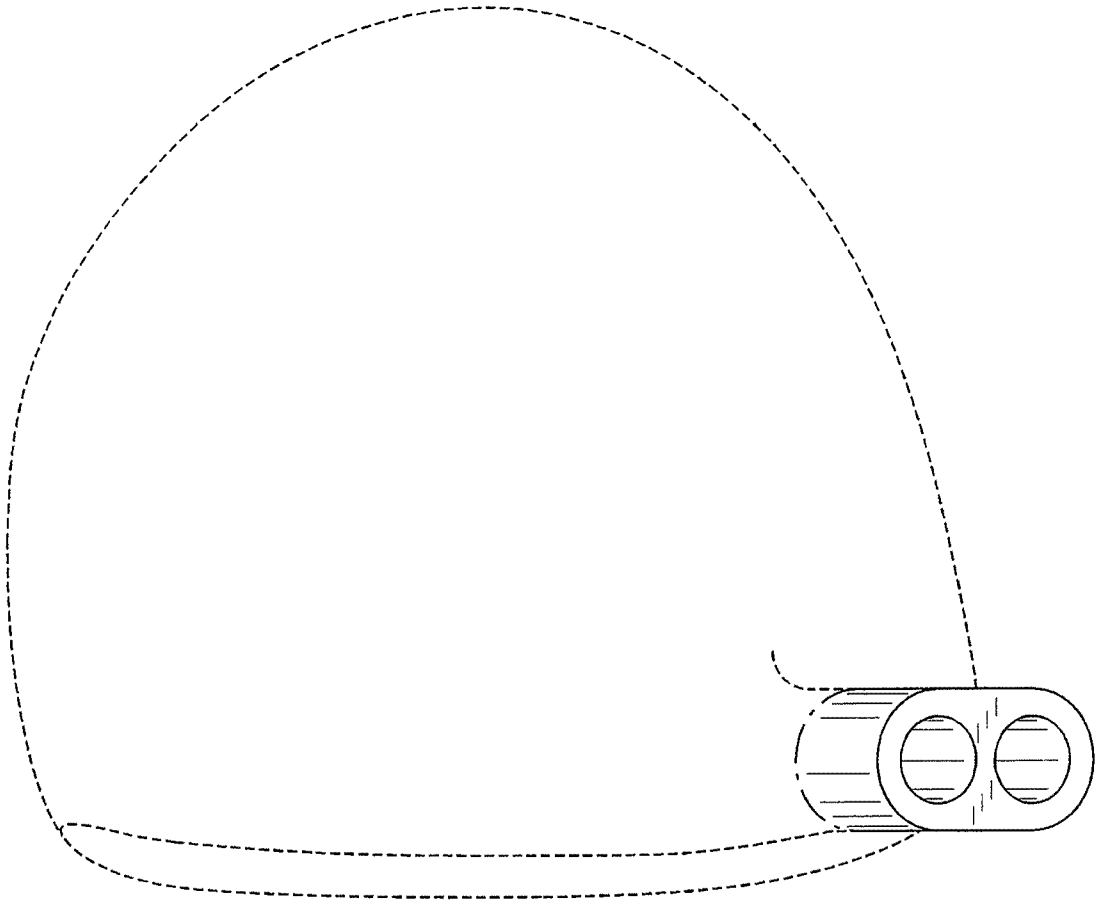

FIG.6

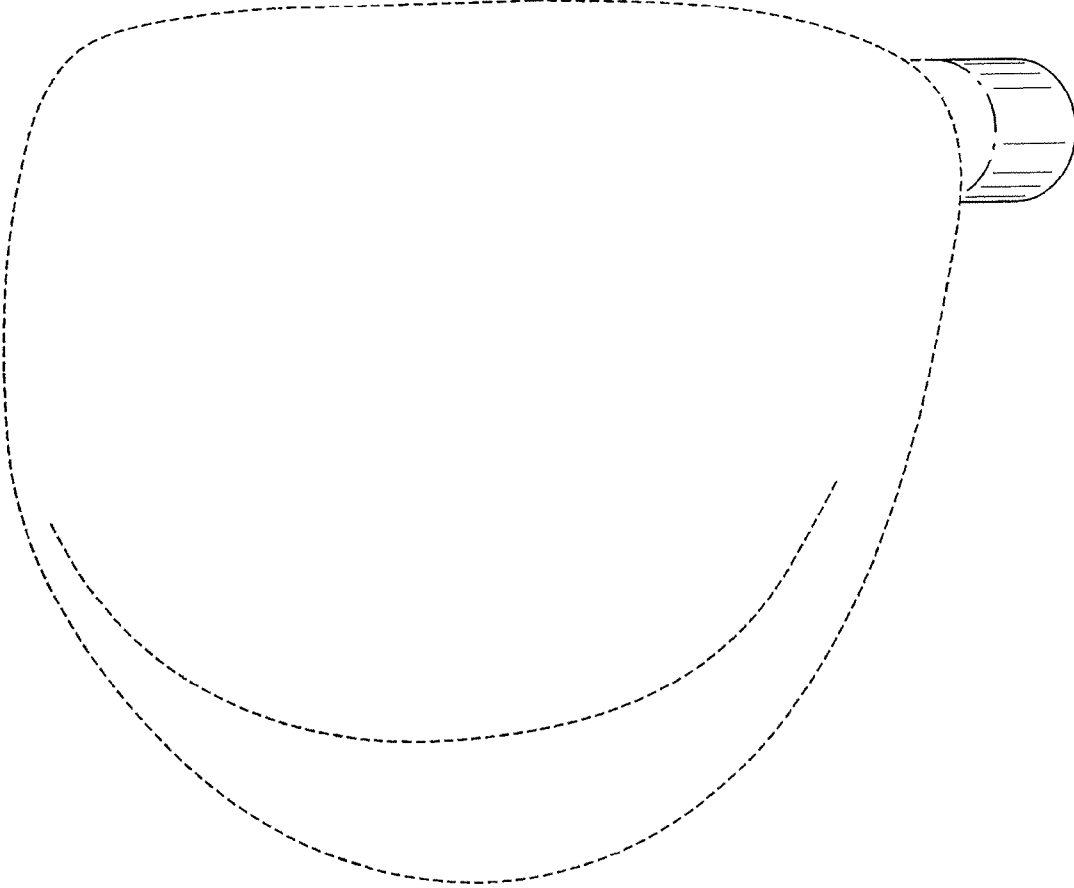

FIG.7